

The data except this specification conform to those of ICX098BL(Spec. No. 01409).

Spot Pixel Specification

(1/30s storage, CCD signal, Ta = 25°C)

Spot pixel	Spot pixel level	Number of allowable spot pixels by zone				Measurement method	Remarks
		0	I	II	II'		
Black or white pixels at high light	$30\% \leq D$	0	0	0	0	1	
Black pixels at low light	$4.0mV \leq D$	0	0	0	0	2	
White pixels in the dark	$24.0mV \leq D$	2				3	Ta = 60°C
Black or white pixels at electronic shutter operation	Same as for black pixels at low light.					4	

Notes

- 1) D ... Spot pixel level.
- 2) Zone III – no evaluation criteria applied.
- 3) In the optical black (OB), the level of white pixels in the dark must be 12mV or less in the horizontal optical black (HOB) and 36mV or less in the vertical optical black (VOB) (Ta = 60°C).
- 4) Zoon definition is illustrated in the figure below.
- 5) The Zone II' specification applies to the black pixels at low light in the shaded area of Zone III on the monitor. (See the figure shown below.)

◎ **Spot Pixel Zone Definition**

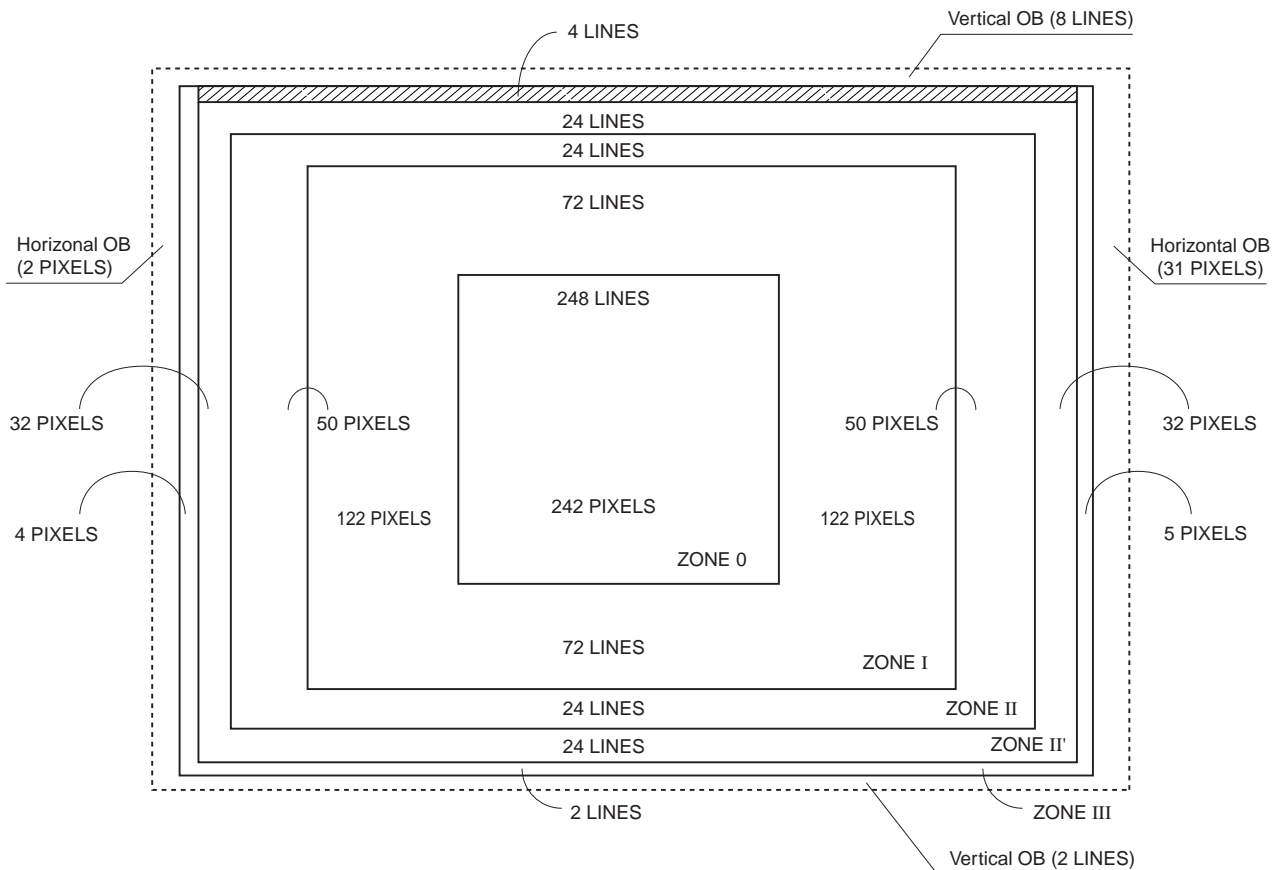

CONFIDENTIAL

Notice on White Pixels Specifications (December 1, 2003 ver.)

After delivery inspection of CCD image sensors, cosmic radiation may distort pixels of CCD image sensors, and then distorted pixels may cause white point effects in dark signals in picture images. (Such white point effects shall be hereinafter referred to as "White Pixels.") Unfortunately, it is not possible with current scientific technology for CCD image sensors to prevent such White Pixels. It is recommended that when you use CCD image sensors, you should consider taking measures against such White Pixels, such as adoption of automatic compensation systems for White Pixels in dark signals and establishment of quality assurance standards.

Unless the Seller's liability for White Pixels is otherwise set forth in an agreement between you and the Seller, Sony Corporation or its distributors (hereinafter collectively referred to as the "Seller") will, at the Seller's expense, replace such CCD image sensors, in the event the CCD image sensors delivered by the Seller are found to be to the Seller's satisfaction, to have over the allowable range of White Pixels as set forth on the previous page under the heading "White and Black Pixels Specifications", within the period of three months after the delivery date of such CCD image sensors from the Seller to you; provided that the Seller disclaims and will not assume any liability after if you have incorporated such CCD image sensors into other products.

Please be aware that Seller disclaims and will not assume any liability for (1) CCD image sensors fabricated, altered or modified after delivery to you, (2) CCD image sensors incorporated into other products, (3) CCD image sensors shipped to a third party in any form whatsoever, or (4) CCD image sensors delivered to you over three months ago. Except the above mentioned replacement by Seller, neither Sony Corporation nor its distributors will assume any liability for White Pixels. Please resolve any problem or trouble arising from or in connection with White Pixels at your costs and expenses.

[For Your Reference] The Occurrence Rate of White Pixels

The chart below shows the predictable data on the occurrence rates of White Pixels in a single-story building in Tokyo at an altitude of 0 meters. It is recommended that you should consider taking measures against White Pixels, such as adoption of automatic compensation systems appropriate for each occurrence rate of White Pixels.

The data in the chart is based on records of past field tests, and signifies estimated occurrence rates calculated according to structures and electrical properties of each device. Moreover, the data in the chart is for your reference purpose only, and is not to be used as part of any CCD image sensor specifications.

Example of Occurrence Rates

White Pixel Level (in case of storage time = 1/30s) (CCD signal, Ta = 60°C)	Occurrence Rate per week
5.6mV or higher	0.5%
10.0mV or higher	0.3%
24.0mV or higher	0.1%
50.0mV or higher	0.1%
72.0mV or higher	0.1%

Note 1) The above data indicates the average occurrence rate of a single White Pixels that will occur when a CCD image sensor is left for a week.

For example, in a case of a device that has a 1% occurrence rate per week at the 5.6mV or higher effect level, this means that if 1,000 devices are left for a week, a total of 10 devices out of the whole 1,000 devices will have a single White Pixels at the 5.6mV or higher effect level.

Note 2) The occurrence rate of White Pixels fluctuates depending on the CCD image sensor storage environment (such as altitude, geomagnetic latitude and building structure), time (solar activity effects) and so on. Moreover, there may be statistic errors. Please take notice and understand that this is an example of test data with experiments that have being conducted over a specific time period and in a specific environment.

Note 3) This data does not guarantee the upper limits of the occurrence rate of White Pixels.

For Your Reference:

The occurrence rate of White Pixels at an altitude of 3,000 meters is from 5 to 10 times more than that at an altitude of 0 meters because of the density of the cosmic rays. In addition, in high latitude geographical areas such as London and New York, the density of cosmic rays increases due to a difference in the geomagnetic density, so the occurrence rate of White Pixels in such areas approximately doubles when compared with that in Tokyo.

- This Notice on White Pixels Specifications (hereinafter referred to as "Notice") is for customers who are considering or currently using CCD image sensors set forth in this White Pixels specifications book. Sony Corporation may, at any time, modify this Notice which will be available to you in the latest White Pixels specifications book. You should abide by the latest version of this Notice. If a subsidiary or distributor of Sony Corporation has its own notice on white pixels specifications, such notice will additionally apply between you and the subsidiary or distributor. You should consult a sales representative of the subsidiary or distributor of Sony Corporation on such notice when you consider using CCD image sensors.
- This Notice shall be governed by and construed in accordance with the laws of Japan, without reference to principles of conflict of laws or choice of laws. All controversies and disputes arising out of or relating to this Notice shall be submitted to the exclusive jurisdiction of the Tokyo District Court in Japan as the court of first instance.

◎ Measurement Method for Spot Pixels

After setting to standard imaging condition II, the device driver should be set to meet bias and clock voltage conditions.

Configure the driver circuit according to the example below and measure at the test point shown.

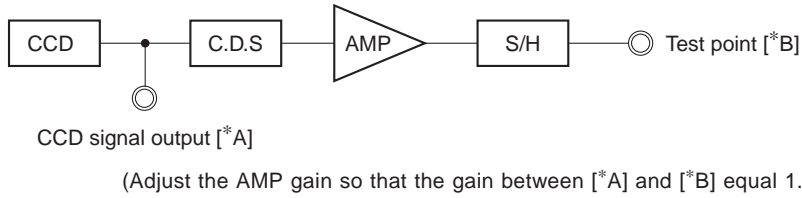

1. Black or white pixels at high light

After adjusting the luminous intensity so that the average value of signal output is 150mV, measure the local dip point (black pixels at high light, V_B) and peak point (white pixels at high light, V_K) in the signal output. Substitute the value into the following formula.

$$\text{Level D} = \frac{V_K(\text{or}) V_B}{150} \times 100 [\%]$$

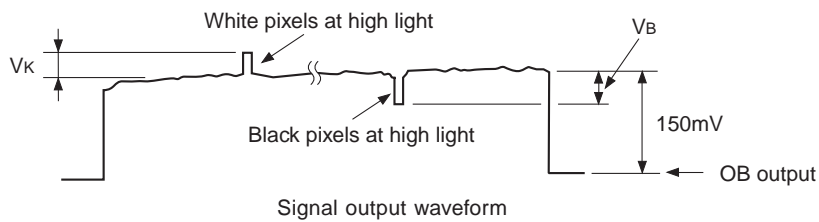

2. Black pixels at low light

After adjusting the luminous intensity so that the average value of signal output is 10mV, measure the local dip point in the signal output.

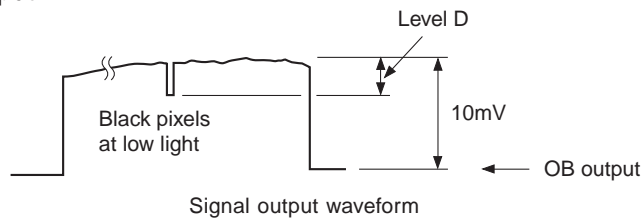

3. White pixels in the dark

Set the device to a dark setting and measure the local peak point of the signal output waveform, using the average value of the dark signal output as a reference.

4. Black or white pixels at electronic shutter operation

Set to electronic shutter operation, adjust the luminous intensity so that the average value of signal output is 10mV, and measure the local dip point (black pixels at electronic shutter operation) and peak point (white pixels at electronic shutter operation).

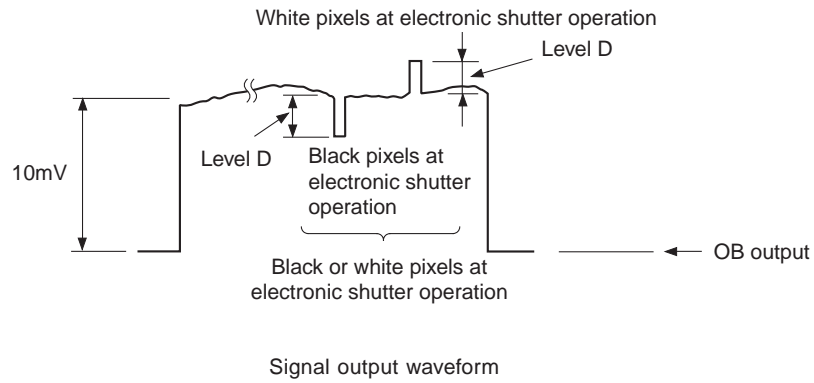

Stain Specifications

Zone	Allowable pixels	Total allowable pixels	Size	Level	Interval
0	1	3	$3 \leq L \leq 10$ lines	$4 \leq R \leq 8\%$	≥ 200 lines
I	2				
II	3		$4 \leq L \leq 20$ lines	$4 \leq R \leq 8\%$	Overlap permitted

For instances of two or more zones, the surface area of the largest zone is used.

© **Stain Zone Definition**

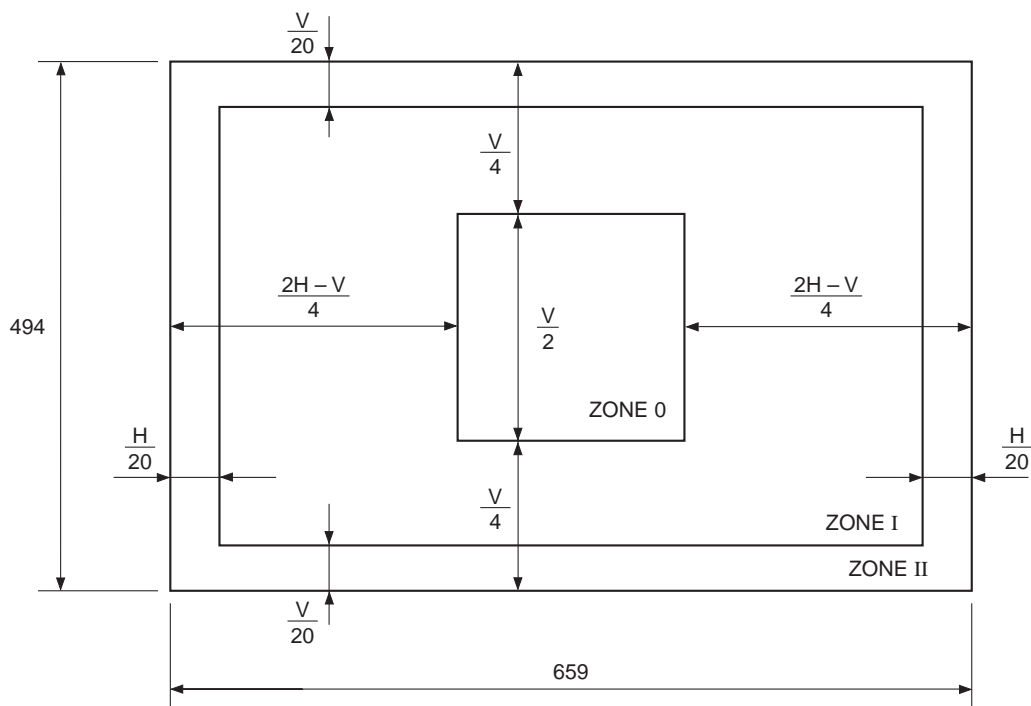

© **Stain Measurement Method**

In the following measurements, set to standard imaging condition II, set the lens iris to F16, and adjust the luminous intensity so that the average value of signal output is 150mV. Measure the local dip in the average value of signal output (V_{BL}) and then calculate the stain level (R) as the ratio of V_{BL} to the average value of signal output.

$$R = \frac{V_{BL}}{150} \times 100 [\%]$$

At the same time, the size (L) of the area where the stain level is 4% or more is determined by line number conversion. The distance from one center of a stain to another is the stain interval, and is also determined in the same fashion by line number conversion.

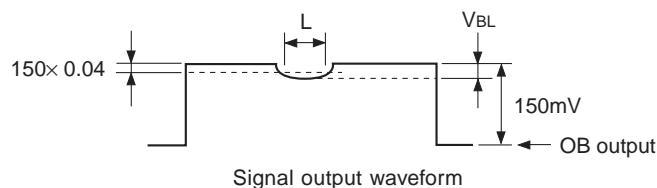

Marking

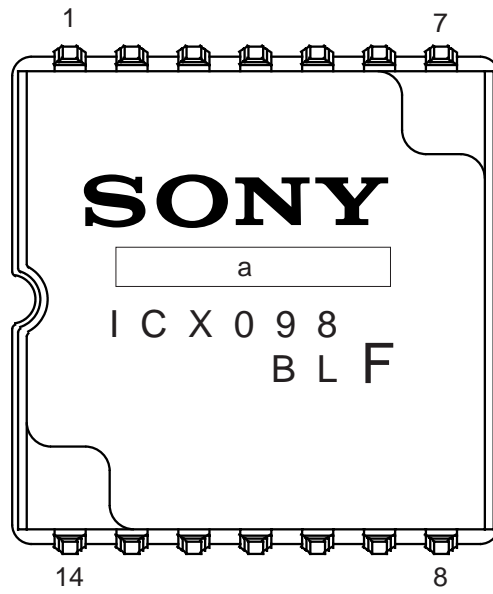

a : Lot No. (Max.7)

